



CELSI 
...the future of fire



PREMIUM ELECTRIC FIRES COLLECTION 2024





WELCOME TO CELSI

At Celsi we know how important it is to create a stylish and relaxing living environment. That's why we've developed this collection of premium electric fires.

I believe our success stems from a combination of innovative design, investment in technology and the highest quality manufacturing standards. To reflect my belief in their quality and durability, Celsi fires carry a minimum of 2 years guarantee, with some models extended by a further 3 years warranty.

This brochure has been designed to make the purchase of your new Celsi heater as simple as possible. I hope you find it both informative and inspiring.

Richard Jones

There is no more versatile fuel for home heating than electricity

With a range that includes beautifully crafted electric suites, feature wall smart fires, classically styled hearth inset fires, and contemporary stove designs, there is a Celsi fire to suit any home. Best of all you are free to enjoy any of these fantastic heating appliances in any room in your home simply by plugging into the nearest mains socket.

To learn more about the features and benefits of owning a Celsi electric fire please sit back and take a few moments to look through our Advanced Features section, along with our technology introduction to assist you in choosing your perfect Celsi fire experience.

ADVANCED FEATURES



THERMOSTATIC HEATING

Pre-set your heat comfort level for automatic temperature control via the handset.



TIMER FUNCTION

Programmable 7-day heating timer with hourly on/off control. Up to 8 hrs sleep timer facility available on some models.



LED EFFICIENCY

Flame picture, fuel bed brightness, mood lighting, our onboard LED's ensure effective energy saving low power consumption.



ISOFLAME

Independent flame effect capable of displaying in isolation when no heat is required from the appliance.



REAL WOOD

100% Real Wood Logs, natural, authentic, and unique. Accept no imitations!



FLAME FUSION

A captivating fusion of soft and natural yellow flames with an attractive flare of blue flame intensity.



COLOUR CYCLE

Fix your favourite or go dynamic as you cycle through an array of impressive colour changing options.



COLOUR SMART

16 colour vibrant presets with 100+ options to customise the light ambience on flames, logs, and ember beds.



MOOD LIGHTS

An ambient stream of colour-rich LED back lighting. Colours to compliment warm and cool interiors, or simply to suit your mood.



CELSI SMART APP

Control your Smart fire or stove from your phone or tablet with full handset functionality. Voice control Alexa and Google Assistant compatible.



Visit App Store or Google Play Store

Scan QR code to download app.



5 year warranty provides 2 years full guarantee and 3 years parts only. Only applicable to electric fire engines.

Fire Surrounds and Fascias are subject to 12 months guarantee.



Compliance with Electrical Energy Rated Product (ERP) Integrated design features for optimal energy saving performance and assurance.



Conformity assessed and certified UK & EU



SUITES Firebeam Luminaire 800

BUILT-IN FIRES E-VR Commodus Smart fires S1000/S1250/S1600

WALL FIRES U-VR Vader Aleesia

HEARTH FIRES U-VR Camber Satin Silver

STOVES E-H3D Hologram Genesis

ELECTRIFLAME®VR

HOLOGRAM®3D

Virtual Reality – Smart & Advanced Flame Projection



Advanced Flame Projection, and Holographic 3D Technologies simulate totally natural log fire effects. Smart connectivity, colours, and configuration raise the appearance and functionality of these electric fires and stoves to new levels.

Smart Functionality 6-7. 3D Hologram Stove 42-43

Freestanding Suites - 3 Sided Glass

E-VR Quantum S1250/S1000	8-9
E-VR Casino S1250/S1000	10-11
E-VR Media 1100/750	12-13
E-VR Carino 1100/750	14-15
E-VR Toronto1000	16-17
E-VR Orbital 1000	18-19

Built-In Fires - 3 Sided Glass

E-VR Commodus S1600	20-21
E-VR Commodus S1250	22-23
E-VR Commodus S1000	24-25
E-VR 1400	26-27
E-VR 1100	28-29
E-VR 750	30

Wall Mounted Suites - 3 Sided Glass

E-VR Volare 750/1100	31-33
----------------------	-------

Wall Inset Fires

E-VR Commodus	34-35
---------------	-------

Wall Mounted Fires

E-VR Louvre	36
E-VR Basilica	37

Hearth Inset Fires

E-VR Acero	38-39
E-VR Parrilla	40-41

Stoves

H3D Hologram Genesis	42-43
E-VR Spectre	44-45
E-VR Stratford	46-47
E-VR Rochester	48-49
E-VR Arundel	50
E-VR Luxima	51

FIREBEAM

ULTIFLAME®VR

Natural Fire Experience

Virtual Reality



Open and Glass fronted technology with 'Real Wood Logs', or natural log effects. Incredible illusions of 'Active Blazing Embers' and intense flame captivation. Styles include luxury Limestone Suites, beautiful wall and hearth inset models, all designed to look sensational and create comfortable controllable warmth.

Real Wood Firebeam Feature 52-53

Firebeam Suites

Firebeam 800/S600/XL 800/XL S600	54-61
Firebeam Luminaire 800/S600	62-63
Firebeam Skyfall 800/S600	64-67

Freestanding Suites

U-VR Orbital 800	68
U-VR Vega	69
U-VR Toronto 800/S600	70-72
U-VR Adour Aleesia/Adour Elite	73-75
U-VR Adour Asencio S/Adour S600	76-77
U-VR Canelo S600	78
U-VR Elara S600	79

Limestone Inset Suites

U-VR Parada Elite	80
U-VR Avignon Elite	81
U-VR Aleesia	82
U-VR Asencio S	83
U-VR Angelo S600	84
U-VR Boticelli S600	85
U-VR Pablo S600	86

Wall Inset Fires

U-VR Elite	87
U-VR Vichy	88
U-VR Metz	89
U-VR Instinct	90
U-VR Evora Asencio S & Asencio S	91
U-VR Vader Aleesia & Aleesia	92-93
U-VR Celena S600	94
U-VR Impulse S600	95

Hearth Inset Fires

U-VR Arcadia	96
U-VR Decadence	97
U-VR Camber	98
U-VR Frontier	99
U-VR Essence	100
U-VR Designer	101
U-VR Endura	102
U-VR Contemporary	103

ELECTRIFLAME®XD

Xtra Dimensional – High Definition Fire



Glass Fronted, extra deep fuel effect with high definition 3D flames. The E-XD range features impressive 'hang-on-the-wall' fires framed with Marble, Limestone, Premier board, and Glass fascia's.

Our XD stoves provide designs that complement both modern and traditional home interiors.

Wall Mounted Fires

E-XD Prestige	104-105
E-XD Black Glass	106
E-XD Royal Botticino	107
E-XD Travertine	108
E-XD Piano Black	109

Stoves

E-XD Metal 1 & 2	110-111
E-XD Glass 1 & 2	112-113

FLAMONIK & ACCENT

Inspired Flame Effect Technologies



Through illusion and LED light technology beautiful flames emerge to provide a range of distinctive electric fire effects that bewilder and excite.

Wall Mounted Fires

Flamonik Rapture	114
Flamonik Enchant	115

Hearth Inset Fires

Accent Traditional	116
Accent Infusion	117

DIMENSIONS

118-127

SMART FUNCTIONALITY



ELECTRIFLAME VR / ULTIFLAME VR / HOLOGRAM®3D

Our next generation smart technology is now available across a wide range of product categories, from 3-sided built-in fires, Limestone and Premier board suites, through to wall inset fires and stoves. The functionality and control of these electric models are most impressive, and best of all they are visually stunning.



COLOUR

Enjoy 16 pre-set ambient colour modes, and over 100+ multi colour combinations to customise the light ambience on flames, logs, and ember beds. To simplify your choice why not relax with a slow cycle through the colour spectrum in our fully immersive Animation mode.



CONNECTIVITY

Get connected with our feature-rich and simple to operate smart app. Available to download on the App Store, or get in on Google Play!



CONTROL

Control your fire from your smart phone or tablet with full handset functionality. Further applied smart technology allows you to voice control your fire using Amazon Alexa and Google Assistant.



Scan the QR code to download our app



CONFIGURATION

Our range of built-in 3-sided glass models offer the perfect solution for your feature wall. Available in three sizes 1000, 1250, and 1600mm.

E-VR Commodus Smart fires are supplied with side blanking panels giving you the option to customise your installation by converting from a 3-sided fire, to a 2-sided left or right configuration, or to simply install as a single glass fronted wall inset fire.



U-VR Evora Asencio S. Wall inset. Page 91



Controllable LED lights positioned above, beneath, and behind the fuelbed creates an illusion of hot embers, burning logs, and tall ascending flames that deliver a real fire experience. These lights operate with 16 preset colour selections, advanced automatic hue cycle, or custom interactive personal choice from 100+ colour preference on flames, logs, and ember bed.



E-VR Commodus S1600. 3-sided glass installation. Page 20-21

QUANTUM S1250/S1000

Electriflame VR Freestanding Smart Illumia Suites

Features

- Flame Projection Technology
- 3 sided glass smart fire
- Dimmable LED surround lighting
- Customisable fuel effect
- Woodland & Silver birch log effect
- Crystal ash embers
- 16 pre-set colours/100+ custom/Animation mode
- LED brightness control
- Thermostatic remote & manual control operation
- Amazon Alexa and Google Assistant compatible



CELSI SMART APP

Feature-rich and simple to operate. Control your fire from your smart phone or tablet with full handset functionality.



E-VR Quantum S1000 Silver Birch Logs

E-VR Quantum S1250 Woodland Logs



Video

Specification

Suite Dimensions: mm	s1250: H 785 x W 1565 x D360 s1000: H 785 x W 1390 x D360
Heat Output	0.8kW - 1.6kW
Suite Finish Painted Premium Board	<input type="checkbox"/> Smooth White
Model Number	Quantum s1250 EVR12RE-SWT Quantum s1000 EVR10RE-SWT

CELSI
SMART



Video

CASINO S1250/S1000

Electrifiame VR Freestanding Smart Suites

Features

- Flame Projection Technology
- 3 sided glass smart fire
- Customisable fuel effect
- Woodland & Silver birch log effect
- Crystal ash embers
- 16 pre-set colours/100+ custom/Animation mode
- LED brightness control
- Thermostatic remote & manual control operation
- Amazon Alexa and Google Assistant compatible



CELSI SMART APP
Feature-rich and simple to operate. Control your fire from your smart phone or tablet with full handset functionality.



E-VR Casino S1000 Silver Birch Logs



E-VR Casino S1250 Woodland Logs



Video

Specification

Suite Dimensions: mm	S1250: H 680 x W 1460 x D274 S1000: H 680 x W 1210 x D274
Heat Output	0.8kW - 1.6kW
Finish Painted Premium Board	<input type="checkbox"/> Smooth White
Model Number	Casino S1250 EVR12CRE-SWT Casino S1000 EVR10CRE-SWT



Video

MEDIA 1100

Electrifiame VR Freestanding Illumia Suite



Video



Features

- Flame Projection Technology
- 3 sided glass fire
- Dimmable LED surround lighting
- Media storage
- Customisable fuel effect
- Silver birch effect logs
- Crystal ash embers
- Single or dual colour flame
- LED brightness control
- Thermostatic remote & manual control operation

Flame Projection Technology



Specification

Suite Dimensions: mm	H 1126 x W 1595 x D 408
Heat Output	1.0kW - 2.0kW
Suite Finish Painted Premium Board	<input type="checkbox"/> Smooth White
Model Number	CEVR11VMRE

MEDIA 750

Electrifiame VR Freestanding Illumia Suite



Video



Features

- Flame Projection Technology
- 3 sided glass fire
- Dimmable LED surround lighting
- Media storage
- Customisable fuel effect
- Silver birch effect logs
- Crystal ash embers
- Single or dual colour flame
- LED brightness control
- Thermostatic remote & manual control operation

Optional Extras

Woodland logs fuel effect



Specification

Suite Dimensions: mm	H 1126 x W 1400 x D 408
Heat Output	1.0kW - 2.0kW
Finish Painted Premium Board	<input type="checkbox"/> Smooth White
Model Number	CEVR75VMRE

CARINO 1100

Electrifiame VR Freestanding Illumia Suite



Video



Features

- Flame Projection Technology
- 3 sided glass fire
- Dimmable LED surround lighting
- Customisable fuel effect
- Silver birch effect logs
- Crystal ash embers
- Single or dual colour flame
- LED brightness control
- Thermostatic remote & manual control operation

Flame Projection Technology



Specification

Suite Dimensions: mm	H 840 x W 1467 x D 370
Heat Output	1.0kW - 2.0kW
Suite Finish Painted Premium Board	<input type="checkbox"/> Smooth White
Model Number	CEVR11CRE

CARINO 750

Electrifiame VR Freestanding Illumia Suite



Video



Features

- Flame Projection Technology
- 3 sided glass fire
- Dimmable LED surround lighting
- Customisable fuel effect
- Silver birch effect logs
- Crystal ash embers
- Single or dual colour flame
- LED brightness control
- Thermostatic remote & manual control operation

Optional Extras

Woodland logs fuel effect



Specification

Suite Dimensions: mm	H 840 x W 1118 x D 370
Heat Output	1.0kW - 2.0kW
Finish Painted Premium Board	<input type="checkbox"/> Smooth White
Model Number	CEVR75CRE

TORONTO 1000

Electrifiame VR Freestanding Illumia Suite

Features

- Flame Projection Technology
- Glass fronted fire
- Dimmable LED surround lighting
- Customisable fuel effect
- Silver birch effect logs
- Crystal ash embers
- Single or dual colour flame
- LED brightness control
- Thermostatic remote & manual control operation



Smooth White



Textured Black & White



Textured White

Specification

Suite Dimensions: mm	H 724 x W 1565 x D 360	
Heat Output	0.8kW - 1.6kW	
Finish Painted Premium Board	<input type="checkbox"/> Smooth White	EFVR40RE-SWT
Model Number	<input type="checkbox"/> Textured White	EFVR40RE-TWH
	<input type="checkbox"/> Textured Black	EFVR40RE-TBW



Video

ORBITAL 1000

Electrifiame VR Freestanding Illumia Suite

Features

- Flame Projection Technology
- Glass fronted fire
- Dimmable LED surround lighting
- Customisable fuel effect
- Silver birch effect logs
- Crystal ash embers
- Single or dual colour flame
- LED brightness control
- Thermostatic remote & manual control operation



Smooth Mist



Smooth White

Specification

Suite Dimensions: mm	H 855 x W 1600 x D 360	
Heat Output	0.8kW - 1.6kW	
Finish Painted Premium Board	<input type="checkbox"/> Smooth White	EFVRSWRE
Model Number	<input type="checkbox"/> Smooth Mist	EFVRSMRE



Video



3-sided glass Installation Woodland Logs



Video

Specification

Fire Dimensions: mm	H 330 x W 1600 x D 219
Heat Output	0.8kW - 1.6kW
Model Number	EFVR16RE

COMMODUS S1600

Electriflame VR Built-In 3 Sided Glass Smart Fire

Features

- Flame Projection Technology
- 3 sided glass smart fire
- Customisable fuel effect
- Woodland & Silver birch effect logs
- Crystal ash embers
- 16 pre-set colours/100+ custom/Animation mode
- LED brightness control
- Thermostatic remote & manual control operation
- Amazon Alexa and Google Assistant compatible
- Side blanking for 2 & 1 sided installations



CELSI SMART APP

Feature-rich and simple to operate. Control your fire from your smart phone or tablet with full handset functionality.





2-sided glass Installation



Video

Specification

Fire Dimensions: mm	H 330 x W 1250 x D 219
Heat Output	0.8kW - 1.6kW
Model Number	EFVR12RE

COMMODUS S1250

Electriflame VR Built-In 3 Sided Glass Smart Fire

Features

- Flame Projection Technology
- 3 sided glass smart fire
- Customisable fuel effect
- Woodland & Silver birch effect logs
- Crystal ash embers
- 16 pre-set colours/100+ custom/Animation mode
- LED brightness control
- Thermostatic remote & manual control operation
- Amazon Alexa and Google Assistant compatible
- Side blanking for 2 & 1 sided installations



CELSI SMART APP

Feature-rich and simple to operate. Control your fire from your smart phone or tablet with full handset functionality.



COMMODUS S1000

Electriflame VR Built-In 3 Sided Glass Smart Fire

Features

- Flame Projection Technology
- 3 sided glass smart fire
- Customisable fuel effect
- Woodland & Silver birch effect logs
- Crystal ash embers
- 16 pre-set colours/100+ custom/Animation mode
- LED brightness control
- Thermostatic remote & manual control operation
- Amazon Alexa and Google Assistant compatible
- Side blanking for 2 & 1 sided installations
- Fascia option available



CELSI SMART APP
Feature-rich and simple to operate. Control your fire from your smart phone or tablet with full handset functionality.



3-sided glass Installation Silver Birch Logs



Wall Inset with Fascia Woodland Logs



Video

Specification

Fire Dimensions: mm	H 330 x W 1000 x D 219
Fascia Dimensions: mm	H 540 x W 1200 x D 19
Heat Output	0.8kW – 1.6kW
Dual Finish Steel Fabricated Fascia Metallic	Black Nickel & Black Metallic
Model Number	Fire & Fascia EFVR10RE070 Fire only EFVR10RE



Video



1400

Electriflame VR Built-In 3 Sided Glass Fire

Features

- Flame Projection Technology
- 3 sided glass fire
- Customisable fuel effect
- Silver birch effect logs
- Crystal ash embers
- Single or dual colour flame
- LED brightness control
- Thermostatic remote & manual control operation
- Side blanking for 2 & 1 sided installations



Flame Projection Technology



Video

Specification

Fire Dimensions: mm	H 375 x W 1430 x D 275
Heat Output	1.0kW - 2.0kW
Model Number	CEVR14RE

1100

Electriflame VR Built-In 3 Sided Glass Fire

Features

- Flame Projection Technology
- 3 sided glass fire
- Customisable fuel effect
- Silver birch effect logs
- Crystal ash embers
- Single or dual colour flame
- LED brightness control
- Thermostatic remote & manual control operation
- Side blanking for 2 & 1 sided installations



Flame Projection Technology



Specification

Fire Dimensions: mm	H 374 x W 1130 x D 275
Heat Output	1.0kW – 2.0kW
Model Number	CEVR11RE



Video

750

Electrifiame VR Built-In 3 Sided Glass Fire



Video



Features

- Flame Projection Technology
- 3 sided glass fire
- Customisable fuel effect
- Silver birch effect logs
- Crystal ash embers
- Single or dual colour flame
- LED brightness control
- Thermostatic remote & manual control operation
- Side blanking for 2 & 1 sided installations

Optional Extras

Woodland logs fuel effect



Specification

Fire Dimensions: mm	H 374 x W 780 x D 275
Heat Output	0.8kW – 1.6kW
Model Number	CEVR75RE

VOLARE 750

Electrifiame VR 3 Sided Glass Fire Wall Mounted Illumia Suite



Video



Features

- Flame Projection Technology
- 3 sided glass fire
- Dimmable LED surround lighting
- Customisable fuel effect
- Silver birch effect logs
- Crystal ash embers
- Single or dual colour flame
- LED brightness control
- Thermostatic remote & manual control operation
- Includes wall fixing bracket

Optional Extras

Woodland logs fuel effect



Specification

Suite Dimensions: mm	H 721 x W 1400 x D 406
Heat Output	1.0kW – 2.0kW
Finish Painted Premium Board	Smooth White
Model Number	CEVR75VRE

VOLARE 1100

Electriflame VR Wall Mounted Illumia Suite

Features

- Flame Projection Technology
- 3 sided glass fire
- Dimmable LED surround lighting
- Customisable fuel effect
- Silver birch effect logs
- Crystal ash embers
- Single or dual colour flame
- LED brightness control
- Thermostatic remote & manual control operation
- Includes wall fixing bracket



Flame Projection Technology



Specification

Suite Dimensions: mm	H 721 x W 1595 x D 406
Heat Output	1.0kW - 2.0kW
Finish Painted Premium Board	<input type="checkbox"/> Smooth White
Model Number	CEVR11VRE



Video

COMMODUS

Electriflame VR Wall Inset Fire

Features

- Flame Projection Technology
- Glass fronted fire
- Customisable fuel effect
- Silver birch effect logs
- Crystal ash embers
- Single or dual colour flame
- LED brightness control
- Thermostatic remote & manual control operation
- Fascia option available



Commodus fascia-less installation



Wall Inset with Fascia option

Specification

Fire Dimensions: mm	H 330 x W 981 x D 169
Fascia Dimensions: mm	H 540 x W 1200 x D 19
Heat Output	0.8kW – 1.6kW
Dual Finish Steel Fabricated Fascia Metallic	 Black Nickel & Black Metallic
Model Number	Fire Only EFVR40RE Fire + Fascia EFVR40RE070



Video

LOUVRE

Electrifiame VR Wall Mounted Fire



Video



Features

- Flame Projection Technology
- Glass fronted fire
- Customisable fuel effect
- Woodland ceramic logs
- Crystal ash embers
- Single or dual colour flame
- LED brightness control
- Thermostatic remote & manual control operation
- Includes wall fixing bracket



Specification

Dimensions: mm	H 519 x W 1102 x D 201
Heat Output	0.8kW - 1.6kW

Dual Finish

Steel Fabricated Brushed Metallic & Glass	Satin Silver & Black Glass
Model Number	CPPSSLRE

BASILICA

Electrifiame VR Wall Mounted Fire



Video



Features

- Flame Projection Technology
- Glass fronted fire
- Customisable fuel effect
- Silver birch effect logs
- Crystal ash embers
- Single or dual colour flame
- LED brightness control
- Thermostatic remote & manual control operation
- Includes wall fixing bracket
- Wall inset option



Specification

Dimensions: mm	H 570 x W 1400 x D 90
Heat Output	0.8kW - 1.6kW



Satin Silver & Black

Dual Finish

Steel Fabricated Brushed Metallic Black Painted	Satin Silver & Black EFVR40RE024
Model Number	Satin Champagne & Black



Chrome & Black Nickel

ACERO

Electriflame VR Hearth Inset Fire

Features

- Aspirational 26 inch fascia
- Flame Projection Technology
- Extra wide glass fronted fire
- Customisable fuel effect
- Real Wood logs
- Crystal ash embers
- Single or dual colour flame
- LED brightness control
- Thermostatic remote & manual control operation



Chrome & Satin Silver



Video

Specification

Dimensions: mm	H 655 x W 657 x D 67
Heat Output	0.75kW - 1.5kW
Dual Finish Steel	<input type="checkbox"/> Chrome & Satin Silver EVRIASRE
Fabricated Fascia Metallic	<input type="checkbox"/> Chrome & Black Nickel EVRIABRE
Model Number	

PARRILLA

Electriflame VR Hearth Inset Fire

Features

- Flame Projection Technology
- Extra wide glass fronted fire
- Customisable fuel effect
- Real Wood logs
- Crystal ash embers
- Single or dual colour flame
- LED brightness control
- Thermostatic remote & manual control operation



Satin Silver



Satin Champagne

Specification

Dimensions: mm	H 602 x W 544 x D 90
Heat Output	0.75kW - 1.5kW

Finish

Steel Fabricated Fascia	Brushed Metallic	<input type="checkbox"/> Satin Silver EVRIPSRE
Model Number		<input type="checkbox"/> Satin Champagne EVRIPCRC



Video



HOLOGRAM GENESIS

Electriflame H3D Smart Stove

Features

- Holographic Im-Mesh 3D Technology •
- Multi Flame Projection Technology •
- Living Ember Bed Technology •
- Tough steel construction
- Curved design
- Woodland ceramic logs
- 16 pre-set colours/100+ custom/Animation mode
- LED brightness control
- Thermostatic remote & manual control operation
- Amazon Alexa and Google Assistant compatible
- Decorative flue pipe available



CELSI SMART APP

Feature-rich and simple to operate. Control your fire from your smart phone or tablet with full handset functionality.

The Holographic Im-Mesh 3D technology offers an extensive number of colour options and combinations. Explore dancing flame witchery and smouldering logs with Living Ember Bed Technology, a desirable effect at the forefront of the electric stoves market.

This exciting new generation of electric fires features patented technologies. It is economical to run with high quality LEDs. The heater is thermostatically controlled with settings options. The fire is simple to use and can be operated manually, by remote control, or via WiFi using our dedicated Celsi app.

The flame picture can be used in isolation to the heat, and is a popular choice when no heat is required during the summer months, offering exceptionally low running costs.

Instant heat can be applied to a room at anytime with full thermostatic control.



Video

Specification

Dimensions: mm	H 800 x W 500 x D 400
Heat Output	1.0kW - 2.0kW
Finish Steel Fabricated Painted	Black
Model Number	ESEHGORE

CELSI
SMART



SPECTRE

Electriflame VR 3 Sided Glass Smart Stoves



Video

Features

- Flame Projection Smart Technology
- 3 sided glass stove
- Customisable fuel effect
- Woodland ceramic logs
- Crystal ash embers
- 16 pre-set colours/100+ custom/Animation mode
- LED brightness control
- Thermostatic remote & manual control operation
- Amazon Alexa and Google Assistant compatible
- Decorative flue pipe available



CELSI SMART APP

Feature-rich and simple to operate. Control your fire from your smart phone or tablet with full handset functionality.



Specification

Dimensions: mm	H 800 x W 500 x D 400
Heat Output	1.0kW – 2.0kW
Finish Steel Fabricated Painted	Black
Model Number	EFVRCSE

Optional Extras

- Decorative Steel Flue Pipe Assembly B-1033451

SPECTRE LS



Video



Specification

Dimensions: mm	H 1095 x W 500 x D 400
Heat Output	1.0kW – 2.0kW
Finish Steel Fabricated Painted	Black
Model Number	EFVRLRE

Optional Extras

- Decorative Steel Flue Pipe Assembly B-1033451





STRATFORD

Electriflame VR Smart Stove

Features

- Flame Projection Smart Technology
- Tough steel body stove
- Customisable fuel effect
- Woodland ceramic logs
- Crystal ash embers
- 16 pre-set colours/100+ custom/Animation mode
- LED brightness control
- Thermostatic remote & manual control operation
- Amazon Alexa and Google Assistant compatible
- Decorative flue pipe available



CELSI SMART APP
 Feature-rich and simple to operate. Control your fire from your smart phone or tablet with full handset functionality.



Video

Specification

Dimensions: mm	H 590 x W 500 x D 330
Heat Output	1.0kW - 2.0kW
Finish Steel Fabricated Painted	 Black
Model Number	EFVRSTRE

ROCHESTER

Electriflame VR Stove

Features

- Flame Projection Technology
- Tough steel body
- Curved door design
- Customisable fuel effect
- Silver birch effect logs
- Crystal ash embers
- Single or dual colour flame
- LED brightness control
- Thermostatic remote & manual control operation



Optional Extras

- Woodland ceramic logs
- Decorative Steel Flue Pipe Accessories



Specification

Dimensions: mm	H 606 x W 532 x D 372
Heat Output	1.0kW - 2.0kW
Finish Steel Fabricated Painted	Black
Model Number	CEVRSRRE



Video

ARUNDEL

Electriflame VR Stove



Video



Features

- Flame Projection Technology
- Tough steel body
- Customisable fuel effect
- Silver birch effect logs
- Crystal ash embers
- Single or dual colour flame
- LED brightness control
- Thermostatic remote & manual control operation



Optional Extras

- Woodland ceramic logs
- Decorative Steel Flue Pipe Accessories



Finish

Steel Fabricated Painted	Black
Model Number	CEVRSARE

Specification

Dimensions: mm	H 582 x W 430 x D 389
Heat Output	1.0kW - 2.0kW

LUXIMA

Electriflame VR Stove



Video



Features

- Flame Projection Technology
- Tough steel body
- Customisable fuel effect
- Silver birch effect logs
- Crystal ash embers
- Single or dual colour flame
- LED brightness control
- Thermostatic remote & manual control operation



Optional Extras

- Woodland ceramic logs
- Decorative Steel Flue Pipe Accessories



Finish

Steel Fabricated Painted	Black
Model Number	CEVRSLRE

Specification

Dimensions: mm	H 595 x W 471 x D 359
Heat Output	1.0kW - 2.0kW

FIREBEAM

NATURAL RANGE

Firebeam products offer a generous full depth fuel bed consisting of a naturally arranged real wood logs, embedded in 'Active Blazing Embers'. The fire realism is sensational, and the natural wood log arrangement is visually stunning.

This new generation electric fire effect is available in a range of contemporary beams and suites, each include integrated dimable LED lighting.



REAL WOOD LOGS

100% Real Wood Logs, natural, authentic, and unique. Accept no imitations!



Page 60-61
Firebeam XL S600 Suite



Page 54-55
Firebeam 800 Suite



Page 64-65
Firebeam Skyfall 800 Suite



Page 63
Firebeam Luminaire S600 Suite



Models include single wall mounted beams smartly framed by sleek glass with chrome fittings. Larger feature wall beams include our 'Firebeam XL' models, these require less wall depth for easy installation.

For a completely fuss-free installation our freestanding suites only require the need to place down and plug in.

All models are premium products with Integrated design features for optimal energy saving performance and assurance.



Active Blazing Embers



FIREBEAM

Active Blazing Embers

FIREBEAM 800

Firebeam Inset Illumia Suite

Features

- Open fire experience
- Dimmable LED surround lighting
- Extra deep fuel bed
- Natural real wood logs
- Active Blazing Embers
- Single or dual colour flame
- LED brightness control
- Thermostatic remote & manual control operation



Smooth White



Smooth Mist

Specification

Suite Dimensions: mm	H 540 x W 1200 x D 170
Heat Output	0.8kW - 1.6kW
Finish Painted Premium Board	<input type="checkbox"/> Smooth White CEULF8RE-SWT
Model Number	<input type="checkbox"/> Smooth Mist CEULF8RE-ELB



Video

FIREBEAM S600

Firebeam Inset Illuvia Smart Suite

Features

- Open fire experience
- Dimmable LED surround lighting
- Extra deep fuel bed
- Natural real wood logs
- Active Blazing Embers
- 16 pre-set colours/100+ custom/Animation mode
- LED brightness control
- Thermostatic remote & manual control operation
- Amazon Alexa and Google Assistant compatible



CELSI SMART APP
 Feature-rich and simple to operate. Control your fire from your smart phone or tablet with full handset functionality.



Smooth Mist



Smooth White

Specification

Suite Dimensions: mm	H 615 x W 870 x D 170
Heat Output	0.8kW - 1.6kW
Finish Painted Premium Board	<input type="checkbox"/> Smooth White CEULFRRE-SWT
Model Number	<input type="checkbox"/> Smooth Mist CEULFRRE-ELB



Video

FIREBEAM XL800

Firebeam Semi-Inset Illumia Suite

Features

- Open fire experience
- Dimmable LED surround lighting
- Extra deep fuel bed
- Natural real wood logs
- Active Blazing Embers
- Single or dual colour flame
- LED brightness control
- Thermostatic remote & manual control operation



Real Wood Logs



Specification

Suite Dimensions: mm	H 697 x W 1302 x D 213
Heat Output	0.8kW - 1.6kW
Finish Painted Premium Board	<input type="checkbox"/> Smooth White
Model Number	CEUXF8RE-SWT



Video

FIREBEAM XL S600

Firebeam Semi-Inset Illumia Smart Suite

Features

- Open fire experience
- Dimmable LED surround lighting
- Extra deep fuel bed
- Natural real wood logs
- Active Blazing Embers
- 16 pre-set colours/100+ custom/Animation mode
- LED brightness control
- Thermostatic remote & manual control operation
- Amazon Alexa and Google Assistant compatible



CELSI SMART APP

Feature-rich and simple to operate. Control your fire from your smart phone or tablet with full handset functionality.



Specification

Suite Dimensions: mm	H 794 x W 970 x D 213
Heat Output	0.8kW - 1.6kW
Finish Painted Premium Board	<input type="checkbox"/> Smooth White
Model Number	CEUXR6RE-SWT



Video

LUMINAIRE 800

Firebeam Freestanding Illumia Suite



Video



Features

- Open fire experience
- Dimmable LED surround lighting
- Extra deep fuel bed
- Natural real wood logs
- Active Blazing Embers
- Single or dual colour flame
- LED brightness control
- Thermostatic remote & manual control operation



Specification

Suite Dimensions: mm	H 1005 x W 1478 x D 400
Heat Output	0.8kW - 1.6kW
Finish Painted Premium Board	<input type="checkbox"/> Smooth White
Model Number	CEULL8RE-SWT

LUMINAIRE S600

Firebeam Freestanding Illumia Smart Suite



Video



Features

- Open fire experience
- Dimmable LED surround lighting
- Extra deep fuel bed
- Natural real wood logs
- Active Blazing Embers
- 16 pre-set colours/100+ custom/Animation mode
- LED brightness control
- Thermostatic remote & manual control operation
- Amazon Alexa and Google Assistant compatible



CELSI SMART APP

Feature-rich and simple to operate. Control your fire from your smart phone or tablet with full handset functionality.



Specification

Suite Dimensions: mm	1108x W 1350 x D 400
Heat Output	0.8kW - 1.6kW
Finish Painted Premium Board	<input type="checkbox"/> Smooth White
Model Number	CEULGLRE-SWT

SKYFALL 800

Firebeam Freestanding Illumia Suite

Features

- Open fire experience
- Dimmable LED surround lighting
- Extra deep fuel bed
- Natural real wood logs
- Active Blazing Embers
- Single or dual colour flame
- LED brightness control
- Thermostatic remote & manual control operation



Smooth White



Smooth White & Mist

Specification

Suite Dimensions: mm	H 775 x W 1480 x D 375
Heat Output	0.8kW - 1.6kW
Finish Painted Premium Board	<input type="checkbox"/> Smooth White CEULS8RE-SWT
Model Number	<input type="checkbox"/> Smooth White & Mist CEULS8RE-ELB



Video

SKYFALL S600

Firebeam Freestanding Illumia Smart Suite

Features

- Open fire experience
- Dimmable LED surround lighting
- Extra deep fuel bed
- Natural real wood logs
- Active Blazing Embers
- 16 pre-set colours/100+ custom/Animation mode
- LED brightness control
- Thermostatic remote & manual control operation
- Amazon Alexa and Google Assistant compatible



CELSI SMART APP
 Feature-rich and simple to operate. Control your fire from your smart phone or tablet with full handset functionality.



Smooth White & Mist



Smooth White & Mist

Specification

Suite Dimensions: mm	H 775 x W 1480 x D 375
Heat Output	0.8kW - 1.6kW
Finish Painted Premium Board	<input type="checkbox"/> Smooth White CEULR6RE-SWT
Model Number	<input type="checkbox"/> Smooth White & Mist CEULR6RE-ELB



Video

ORBITAL 800

Ultiflame VR Freestanding Illumia Suite



Video



Smooth Mist

Features

- Open fire experience
- Dimmable LED surround lighting
- Customisable fuel effect
- Silver birch effect logs
- Crystal ash embers
- Single or dual colour flame
- LED brightness control
- Thermostatic remote & manual control operation



Smooth Cream



Smooth White

Suite Finish

- | | |
|-----------------------|--|
| Painted Premium Board | <input type="checkbox"/> Smooth White CEULOWRE-ERP |
| Black inner panel | <input type="checkbox"/> Smooth Mist CEULOMRE-ERP |
| Model Number | <input type="checkbox"/> Smooth Cream CEULOCRE-ERP |

Specification

Suite Dimensions: mm	H 850 x W 1466 x D 360
Heat Output	0.8kW - 1.6kW

VEGA

Ultiflame VR Freestanding Illumia Suite



Video



Features

- Open fire experience
- Customisable fuel effect
- Silver birch effect logs
- Crystal ash embers
- Single or dual colour flame
- LED brightness control
- Thermostatic remote & manual control operation



Specification

Suite Dimensions: mm	H 892 x W 1430 x D 330
Heat Output	0.8kW - 1.6kW

Suite Finish

- | | |
|-----------------------|---------------------------------------|
| Painted Premium Board | <input type="checkbox"/> Smooth White |
| Black inner panel | |
| Model Number | CEULVWRE-ERP |

TORONTO 800

Ultiflame VR Freestanding Illumia Suite

Features

- Open fire experience
- Dimmable LED surround lighting
- Customisable fuel effect
- Silver birch effect logs
- Crystal ash embers
- Single or dual colour flame
- LED brightness control
- Thermostatic remote & manual control operation



Smooth White



Textured Black & White



Textured White

Specification

Suite Dimensions: mm	H 740 x W 1465 x D 360
Heat Output	0.8kW - 1.6kW
Finish Painted Premium Board	<input type="checkbox"/> Smooth White CEUL9GRE-SWT <input type="checkbox"/> Textured White CEUL9GRE-TWH <input type="checkbox"/> Textured Black CEUL9GRE-TBW
Model Number	



Video

TORONTO S600

Ultriflame VR Freestanding Illumia Smart Suite



Video



Textured White

Features

- Open Fronted Fire
- Dimmable LED surround lighting
- Customisable fuel effect
- Woodland logs
- Charcoal embers
- 16 pre-set colours/100+ custom/Animation mode
- LED brightness control
- Thermostatic remote & manual control operation
- Amazon Alexa and Google Assistant compatible



Smooth White



Textured Black & White



CELSI SMART



Specification

Suite Dimensions: mm	H 835 W 1185 D 360
Heat Output	0.8kW – 1.6kW
Paint finish Premium Board	<input type="checkbox"/> Smooth White CEUL6RRE-SWT <input type="checkbox"/> Textured White CEUL6RRE-TWH <input type="checkbox"/> Textured Black CEUL6RRE-TBW
Model Number	

ADOUR ALEESIA

Ultriflame VR Freestanding Illumia Suite



Video



Features

- Glass Fronted Fire
- Dimmable LED surround lighting
- Customisable fuel effect
- Silver birch effect logs
- Crystal ash embers
- Single or dual colour flame
- LED brightness control
- Thermostatic remote & manual control operation

Flame Fusion – dual colour



Specification

Suite Dimensions: mm	H 990 x W 1465 x D 380
Heat Output	0.8kW – 1.6kW

Suite Finish

Painted Premium Board	<input type="checkbox"/> Smooth White
Model Number	CEUALRE-WWS

Smooth White



ADOUR ELITE

Ultriflame VR Freestanding Illumia Suite

Features

- Open fire experience
- Dimmable LED surround lighting
- Customisable fuel effect
- Silver birch effect logs
- Crystal ash embers
- Single or dual colour flame
- LED brightness control
- Thermostatic remote & manual control operation



Smooth Mist



Smooth Cream



Video

Specification

Suite Dimensions: mm	H 990 x W 1465 x D 380
Heat Output	0.8kW - 1.6kW
Finish Painted Premium Board	<input type="checkbox"/> Smooth White CEULA3REWO
Model Number	<input type="checkbox"/> Smooth Mist CEULA3RESO
	<input type="checkbox"/> Smooth Cream CEULA3RECO

ADOUR ASENCIO S

Ultriflame VR Freestanding Illumia Smart Suite



Video



Features

- Glass Fronted Fire
- Dimmable LED surround lighting
- Customisable fuel effect
- Woodland logs
- Charcoal embers
- 16 pre-set colours/100+ custom/Animation mode
- LED brightness control
- Thermostatic remote & manual control operation
- Amazon Alexa and Google Assistant compatible



Specification

Suite Dimensions: mm	H 1090 x W 1340 x D 380
Heat Output	0.8kW – 1.6kW
Painted Premium Board Black back panel and hearth	Smooth White & Black
Model Number	CEULARRE-WBS



CELSI SMART APP

Feature-rich and simple to operate. Control your fire from your smart phone or tablet with full handset functionality.

ADOUR S600

Ultriflame VR Freestanding Illumia Smart Suite



Video



Features

- Open Fronted Fire
- Dimmable LED surround lighting
- Customisable fuel effect
- Woodland logs
- Charcoal embers
- 16 pre-set colours/100+ custom/Animation mode
- LED brightness control
- Thermostatic remote & manual control operation
- Amazon Alexa and Google Assistant compatible



Specification

Suite Dimensions: mm	H 1090 x W 1340 x D 380
Heat Output	0.8kW – 1.6kW
Painted Premium Board Black back panel and hearth	Smooth White & Black
Model Number	CEULA2REWB



CELSI SMART APP

Feature-rich and simple to operate. Control your fire from your smart phone or tablet with full handset functionality.

CANELO S600

Ultriflame VR Freestanding Illumia Smart Suite



Video



Features

- Open Fronted Fire
- Dimmable LED surround lighting
- Customisable fuel effect
- Woodland logs
- Charcoal embers
- 16 pre-set colours/100+ custom/Animation mode
- LED brightness control
- Thermostatic remote & manual control operation
- Amazon Alexa and Google Assistant compatible



Specification

Suite Dimensions: mm	H 1090 W 1340 D 340
Heat Output	0.8kW – 1.6kW
Painted Premium Board Black back panel and hearth	Smooth White & Black
Model Number	CEUL6IRE-RGB



CELSI SMART APP

Feature-rich and simple to operate. Control your fire from your smart phone or tablet with full handset functionality.

ELARA S600

Ultriflame VR Freestanding Smart Suite



Video



Features

- Open Fronted Fire
- Customisable fuel effect
- Woodland logs
- Charcoal embers
- 16 pre-set colours/100+ custom/Animation mode
- LED brightness control
- Thermostatic remote & manual control operation
- Amazon Alexa and Google Assistant compatible



Smooth Cream & Black



Smooth White & Black



Specification

Suite Dimensions: mm	H 892 x W 1228 x D 330
Heat Output	0.8kW – 1.6kW
Painted Premium Board Black back panel and hearth	Smooth White & Black CEULEWRE-RGB Smooth Mist & Black CEULEMRE-RGB
Model Number	Smooth Cream & Black CEULECRE-RGB



CELSI SMART APP

Feature-rich and simple to operate. Control your fire from your smart phone or tablet with full handset functionality.



PARADA ELITE

Ultiflame VR Inset Limestone Illumia Suite



Video



Features

- Open fire experience
- Dimmable LED surround lighting
- Customisable fuel effect
- Silver birch effect logs
- Crystal ash embers
- Single or dual colour flame
- LED brightness control
- Thermostatic remote & manual control operation
- Available in two sizes



Specification

Suite Dimensions: mm	54" 58"	H 990 x W 1350 x D 400 H 990 x W 1464 x D 400
Heat Output	0.8kW – 1.6kW	

Suite Finish

Natural	<input type="checkbox"/> Limestone
Model Number	54" CEULPSRE-ERP 58" CEULPRE-ERP

AVIGNON ELITE

Ultiflame VR Inset Limestone Suite



Video



Features

- Open fire experience
- Customisable fuel effect
- Silver birch effect logs
- Crystal ash embers
- Single or dual colour flame
- LED brightness control
- Thermostatic remote & manual control operation
- Available in two sizes



Specification

Suite Dimensions: mm	54" 58"	H 990 x W 1350 x D 380 H 990 x W 1464 x D 380
Heat Output	0.8kW – 1.6kW	

Suite Finish

Natural	<input type="checkbox"/> Limestone
Model Number	54" CEUALRE-ERP 58" CEULASRE-ERP

ALEESIA

Ultiflame VR Inset Limestone Illumia Suite



Video



Features

- Glass Fronted Fire
- Dimmable LED surround lighting
- Customisable fuel effect
- Silver birch effect logs
- Crystal ash embers
- Single or dual colour flame
- LED brightness control
- Thermostatic remote & manual control operation
- Available in two sizes



Specification

Suite Dimensions: mm	54" 58"	H 1050 x W 1370 x D 400 H 1050 x W 1470 x D 400
Heat Output	0.8kW – 1.6kW	

Suite Finish

Natural	<input type="checkbox"/> Limestone
Model Number	54" CEULAS4RE 58" CEULAS8RE

ASENCIO S

Ultiflame VR Inset Limestone Smart Suite



Video



Features

- Glass Fronted Fire
- Customisable fuel effect
- Woodland logs
- Charcoal embers
- 16 pre-set colours/100+ custom/Animation mode
- LED brightness control
- Thermostatic remote & manual control operation
- Amazon Alexa and Google Assistant compatible



CELSI SMART APP

Feature-rich and simple to operate. Control your fire from your smart phone or tablet with full handset functionality.



Specification

Suite Dimensions: mm	H 1095 x W 1376 x D 380
Heat Output	0.8kW – 1.6kW
Natural	<input type="checkbox"/> Limestone
Model Number	CEULASSRE

ANGELO S600

Ultriflame VR Inset Limestone Smart Suite



Video



Features

- Open fire experience
- Customisable fuel effect
- Woodland logs
- Charcoal embers
- 16 pre-set colours/100+ custom/Animation mode
- LED brightness control
- Thermostatic remote & manual control operation
- Amazon Alexa and Google Assistant compatible



CELSI SMART APP
Feature-rich and simple to operate. Control your fire from your smart phone or tablet with full handset functionality.

Specification

Suite Dimensions: mm	H 1070 x W 1370 x D 380
Heat Output	0.8kW - 1.6kW
Natural	<input type="checkbox"/> Limestone
Model Number	CEULLIRE-RGB

BOTICELLI S600

Ultriflame VR Inset Limestone Smart Suite



Video



Features

- Open fire experience
- Customisable fuel effect
- Woodland logs
- Charcoal embers
- 16 pre-set colours/100+ custom/Animation mode
- LED brightness control
- Thermostatic remote & manual control operation
- Amazon Alexa and Google Assistant compatible



CELSI SMART APP
Feature-rich and simple to operate. Control your fire from your smart phone or tablet with full handset functionality.

Specification

Suite Dimensions: mm	H 1060 x W 1370 x D 380
Heat Output	0.8kW - 1.6kW
Natural	<input type="checkbox"/> Limestone
Model Number	CEULAVRE-RGB

PABLO S600

Ultriflame VR Inset Limestone Smart Suite



Video



Features

- Open fire experience
- Customisable fuel effect
- Woodland logs
- Charcoal embers
- 16 pre-set colours/100+ custom/Animation mode
- LED brightness control
- Thermostatic remote & manual control operation
- Amazon Alexa and Google Assistant compatible



CELSI SMART APP

Feature-rich and simple to operate. Control your fire from your smart phone or tablet with full handset functionality.

Specification

Suite Dimensions: mm	H 1060 x W 1220 x D 410
Heat Output	0.8kW - 1.6kW
Natural	<input type="checkbox"/> Limestone
Model Number	CEULRSRE-RGB

ELITE

Ultriflame VR Wall Inset Fire



Video



Features

- Open fire experience
- Customisable fuel effect
- Silver birch effect logs
- Crystal ash embers
- Single or dual colour flame
- LED brightness control
- Thermostatic remote & manual control operation



Specification

Fire Dimensions: mm	H 352 x W 843 x D 182
Heat Output	0.8kW - 1.6kW
Model Number	CEUL33RE-ERP

VICHY

Ultiflame VR Wall Inset Fire



Video



Satin Silver

Features

- Open fire experience
- Customisable fuel effect
- Silver birch effect logs
- Crystal ash embers
- Single or dual colour flame
- LED brightness control
- Thermostatic remote & manual control operation



Specification

Dimensions: mm	H 540 x W 1490 x D 71
Heat Output	0.8kW - 1.6kW



Black Textured



Satin Champagne

Finish

Steel Fabricated Fascia
Brushed Metallic
or Black Textured Paint

Model Number

-  Satin Champagne CEUL33RE971
-  Black Textured CEUL33RE915

METZ

Ultiflame VR Wall Inset Fire



Video



Satin Champagne

Features

- Open fire experience
- Customisable fuel effect
- Silver birch effect logs
- Crystal ash embers
- Single or dual colour flame
- LED brightness control
- Thermostatic remote & manual control operation



Specification

Dimensions: mm	H 540 x W 1490 x D 22.5
Heat Output	0.8kW - 1.6kW



Satin Silver

Finish

Steel Fabricated Fascia
Brushed Metallic

Model Number

-  Satin Silver CEUL33RE919
-  Satin Champagne CEUL33RE931

INSTINCT

Ultriflame VR Wall Inset Fire



Video



Satin Champagne

Features

- Open fire experience
- Customisable fuel effect
- Silver birch effect logs
- Crystal ash embers
- Single or dual colour flame
- LED brightness control
- Thermostatic remote & manual control operation



Satin Black



Specification

Dimensions: mm	H 647 x W 1138 x D 60
Heat Output	0.8kW - 1.6kW

Finish

Steel Fabricated Fascia	Satin Champagne CECH33RE-ERP
Steel Fabricated Fascia	Satin Black CEBC33RE-ERP
Brushed Metallic	

Model Number

EVORA ASENCIO S & ASENCIO S

Ultriflame VR Wall Inset Smart Fire



Video



Evora Asencio

Features

- Glass Fronted Fire
- Customisable fuel effect
- Woodland logs
- Charcoal embers
- 16 pre-set colours/100+ custom/Animation mode
- LED brightness control
- Thermostatic remote & manual control operation
- Amazon Alexa and Google Assistant compatible



Asencio S trimless installation



CELSI SMART APP
Feature-rich and simple to operate. Control your fire from your smart phone or tablet with full handset functionality.

Specification

Dimensions Evora: mm	H 768 x W 762 x D 19
Heat Output	0.8kW - 1.6kW
Steel Fabricated Fascia	Black Nickel & Chrome
Dual Finish Metallic	Evora Asencio CEULASRE-FAS
Model Number	Asencio CEULASRE-RGB

Vader Aleesia Black Nickel & Black



VADER ALEESIA & ALEESIA

Ultiflame VR Wall Inset Fire

Features

- Glass fronted fire
- Customisable fuel effect
- Silver birch effect logs
- Crystal ash embers
- Single or dual colour flame
- LED brightness control
- Thermostatic remote & manual control operation



Vader Aleesia Black Nickel & Chrome



Aleesia trimless installation



Video

Specification

Dimensions: mm	Vader Aleesia H 683 x W 963 x D 21 Aleesia H 490 x W 770 x D 183
Heat Output	0.8kW - 1.6kW
Steel Fabricated Fascia Dual Metallic Finish	 Black Nickel & Black CEULALRE-BNB
Model Number	 Black Nickel & Chrome CEULALRE-BNC  Aleesia CEULALRE

CELENA S600

Ultriflame VR Wall Inset Smart Fire



Video



Features

- Open fire experience
- Customisable fuel effect
- Woodland logs
- Charcoal embers
- 16 pre-set colours/100+ custom/Animation mode
- LED brightness control
- Thermostatic remote & manual control operation
- Amazon Alexa and Google Assistant compatible



Specification

Fire Dimensions: mm	H 447 x W 560 x D 182
Heat Output	0.8kW - 1.6kW
Model Number	CEUL22RE-RGB



CELSI SMART APP
Feature-rich and simple to operate. Control your fire from your smart phone or tablet with full handset functionality.

IMPULSE S600

Ultriflame VR Wall Inset Smart Fire



Video



Satin Black

Features

- Open fire experience
- Customisable fuel effect
- Woodland logs
- Charcoal embers
- 16 pre-set colours/100+ custom/Animation mode
- LED brightness control
- Thermostatic remote & manual control operation
- Amazon Alexa and Google Assistant compatible



CELSI SMART

Satin Silver



Specification

Dimensions: mm	H 742 x W 860 x D 60
Heat Output	0.8kW - 1.6kW
Steel Fabricated Fascia Brushed Metallic	<input type="checkbox"/> Satin Silver CESS22RE-RGB <input type="checkbox"/> Satin Black CEBC22RE-RGB
Model Number	



CELSI SMART APP
Feature-rich and simple to operate. Control your fire from your smart phone or tablet with full handset functionality.

ARCADIA

Ultiflame VR Hearth Inset Fire



Video

Features

- Open fire experience
- Customisable fuel effect
- Natural real wood logs
- Charcoal embers
- Single or dual colour flame
- LED brightness control
- Thermostatic remote & manual control operation



Optional Extras

75mm Spacer frame
For flat wall installation



Black & Chrome

Finish

High Quality Cast Iron
Fascia Paint and Metallic
Plated

Model Number

- Black & Gold CUFLAGRE-ERP
- Black & Chrome CUFLASRE-ERP



Black & Gold

Specification

Dimensions: mm	H 612 x W 528 x D 154
Heat Output	0.75kW - 1.5kW

DECADENCE

Ultiflame VR Hearth Inset Fire



Video

Features

- Open fire experience
- Customisable fuel effect
- Natural real wood log
- Charcoal embers
- Single or dual colour flame
- LED brightness control
- Thermostatic remote & manual control operation



Optional Extras

75mm Spacer frame
For flat wall installation



Gold

Black Nickel



Chrome

Finish

High Quality Cast Iron
Fascia Metallic Plated

Model Number

- Chrome CUFLDRE-ERP
- Gold CUFLDGRE-ERP
- Black Nickel CUFLNDRE-ERP

Specification

Dimensions: mm	H 630 x W 528.5 x D 151
Heat Output	0.75kW - 1.5kW

CAMBER

Ultiflame VR Hearth Inset Fire



Video



Satin Silver

Features

- Open fire experience
- Customisable fuel effect
- Natural real wood logs
- Charcoal embers
- Single or dual colour flame
- LED brightness control
- Thermostatic remote & manual control operation



Optional Extras

75mm Spacer frame
For flat wall installation



Satin Champagne

Black Textured

Finish

- Anodised Aluminium
- Fascia Brushed Metallic or Black Textured Paint
- Model Number
-  Satin Silver CUFLWORE-ERP
 -  Satin Champagne CUFLAORE-ERP
 -  Black Textured CUFLBORE-ERP

Specification

Dimensions: mm	H 619 x W 537 x D 135
Heat Output	0.75kW - 1.5kW

FRONTIER

Ultiflame VR Hearth Inset Fire



Video



Features

- Open fire experience
- Customisable fuel effect
- Natural real wood logs
- Charcoal embers
- Single or dual colour flame
- LED brightness control
- Thermostatic remote & manual control operation



Optional Extras

75mm Spacer frame
For flat wall installation

Specification

Dimensions: mm	H 617 x W 541 x D 131
Heat Output	0.75kW - 1.5kW

Dual Finish

- Steel Fabricated Fascia Paint & Metallic
- Model Number
-  Black Textured & Chrome
- CUFLFSRE-ERP

ESSENCE

Ultiflame VR Hearth Inset Fire



Video



Black

Features

- Open fire experience
- Customisable fuel effect
- Natural real wood logs
- Charcoal embers
- Single or dual colour flame
- LED brightness control
- Thermostatic remote & manual control operation



Optional Extras

75mm Spacer frame
For flat wall installation



Satin Silver

Specification

Dimensions: mm	H 619 x W 537 x D 127
Heat Output	0.75kW - 1.5kW

Finish

- Steel Fabricated Fascia
 - Brushed Metallic
 - Smooth Black Paint
 - Model Number
- Satin Silver CUFLDRE-ERP
 - Smooth Black CUFLD2RE-ERP

DESIGNER

Ultiflame VR Hearth Inset Fire



Video



Black Nickel & Chrome

Features

- Open fire experience
- Customisable fuel effect
- Natural real wood logs
- Charcoal embers
- Single or dual colour flame
- LED brightness control
- Thermostatic remote & manual control operation



Optional Extras

75mm Spacer frame
For flat wall installation



Chrome & Black

Specification

Dimensions: mm	H 599 x W 498 x D 129
Heat Output	0.75kW - 1.5kW

Dual Finish

- Steel Fabricated Fascia
 - Metallic
 - Model Number
- Black Nickel & Chrome CUFLDSRE-ERP
 - Chrome & Black CUFLCBRE-ERP

ENDURA

Ultiflame VR Hearth Inset Fire



Video



Chrome

Features

- Open fire experience
- Customisable fuel effect
- Natural real wood logs
- Charcoal embers
- Single or dual colour flame
- LED brightness control
- Thermostatic remote & manual control operation



Optional Extras

75mm Spacer frame
For flat wall installation



Black

Finish

Steel Fabricated Fascia
Metallic or Smooth Black Paint
Model Number

-  Chrome CUFLESRE-ERP
-  Black CUFLEBRE-ERP

Specification

Dimensions: mm	H 598 x W 497 x D 126
Heat Output	0.75kW - 1.5kW

CONTEMPORARY

Ultiflame VR Hearth Inset Fire



Video



Satin Silver

Features

- Open fire experience
- Customisable fuel effect
- Natural real wood logs
- Charcoal embers
- Single or dual colour flame
- LED brightness control
- Thermostatic remote & manual control operation



Optional Extras

75mm Spacer frame
For flat wall installation



Satin Champagne

Finish

Steel Fabricated Fascia
Brushed Metallic
Model Number

-  Satin Silver CUFCSRE-ERP
-  Satin Champagne CUFCCRE-ERP

Specification

Dimensions: mm	H 598 x W 493 x D 132
Heat Output	0.75kW - 1.5kW

PRESTIGE

Electriflame XD Wall Mounted Fire

Features

- Glass fronted fire
- High definition effect
- Extra deep 3D coals
- Relaxing smoky flames
- LED brightness control
- Thermostatic remote & manual control operation
- Includes wall fixing bracket



Atmospheric flame ascension



Specification

Dimensions: mm	H 600 x W 1100 x D 150
Heat Output	0.75kW - 1.5kW
Finish Natural Marble	 Prestige Brown
Model Number	EFH11TBRE



Video

BLACK GLASS

Electriflame XD Wall Mounted Fire



Video

Black Glass 1300



Features

- Glass fronted fire
- High definition effect
- Extra deep 3D coals
- Relaxing smoky flames
- LED brightness control
- Thermostatic remote & manual control operation
- Includes wall fixing bracket
- Available in two sizes



Black Glass 1100



Specification

Dimensions: mm	H 600 x W 1300 & 1100 x D 126
Heat Output	0.75kW - 1.5kW

Finish

Glass	Black Glass
Model Number	1300 EFH13BGRE 1100 EFH11BGRE

ROYAL BOTTICINO

Electriflame XD Wall Mounted Fire



Video



Features

- Glass fronted fire
- High definition effect
- Extra deep 3D coals
- Relaxing smoky flames
- LED brightness control
- Thermostatic remote & manual control operation
- Includes wall fixing bracket



Specification

Dimensions: mm	H 600 x W 1100 x D 150
Heat Output	0.75kW - 1.5kW

Finish

Natural Marble	Royal Botticino
Model Number	EFH11RBRE

TRAVERTINE

Electriflame XD Wall Mounted Fire



Video

Travertine 1100



Features

- Glass fronted fire
- High definition effect
- Extra deep 3D coals
- Relaxing smoky flames
- LED brightness control
- Thermostatic remote & manual control operation
- Includes wall fixing bracket
- Available in two sizes



Travertine 1300



Specification

Dimensions: mm	H 625 x W 1300 & 1100 x D 150
Heat Output	0.75kW - 1.5kW

Finish

Natural	Travertine
Model Number	EFH11TVRE

PIANO BLACK

Electriflame XD Wall Mounted Fire



Video



Features

- Glass fronted fire
- High definition effect
- Extra deep 3D coals
- Relaxing smoky flames
- LED brightness control
- Thermostatic remote & manual control operation
- Includes wall fixing bracket



Specification

Dimensions: mm	H 600 x W 1300 x D 150
Heat Output	0.75kW - 1.5kW

Finish

Glossy Painted	Black
Model Number	EFH13PBRE

Metal 2



METAL 1 & 2

Electr stove XD Stove

Features

- Tough steel body & door
- High definition effect
- Extra deep 3D coals
- Relaxing smoky flames
- LED brightness control
- Thermostatic remote & manual control operation



THERMO-STATIC

8 HOUR TIMER

ENERGY SAVING

ISO FLAME



Metal 1



METAL 1 Video



METAL 2 Video

Specification

Dimensions: mm	Metal 1 Metal 2	H 579 x W 430 x D 332 H 587 x W 524 x D 295
Heat Output		1.0kW - 2.0kW
Finish Steel Fabricated Body		Black
Model Number	Metal 1 Metal 2	CESSMDRE-ERP CESLMDRE-ERP

Optional Extras

- Decorative Steel Flue Pipe Accessories

GLASS 1 & 2

Electr stove XD Stove

Features

- Tough steel body
- Glass door & stove top
- High definition effect
- Extra deep 3D coals
- Relaxing smoky flames
- LED brightness control
- Thermostatic remote & manual control operation



Glass 2



GLASS 2
Video



Glass 1

Specification

Dimensions: mm	Glass 1 Glass 2	H 583 x W 430 x D 334 H 591 x W 524 x D 295
Heat Output		1.0kW – 2.0kW
Finish Steel Fabricated Body Glass Door		 Black Glass & Chrome
Model Number		Glass 1 CESSMDRE-ERP Glass 2 CESLMDRE-ERP



GLASS 1
Video

RAPTURE

Flamonik Wall Mounted Fire



Video



Features

- Flat glass fascia
- Distinctive flame effect
- Raised log fuel bed
- Thermostatic remote & manual control operation
- Includes wall fixing bracket



Magenta



Blue



Amber



Specification

Dimensions: mm	H 440 x W 686 x D 110
Heat Output	0.75kW - 1.5kW

Finish

	Black Glass
Model Number	CFECRORE-ERP

ENCHANT

Flamonik Wall Mounted Fire



Video



Features

- Curved glass fascia
- Enchanting smoky flame effect
- Raised log fuel bed
- Thermostatic remote & manual control operation
- Includes wall fixing bracket



Magenta



Blue



Amber



Specification

Dimensions: mm	H 441 x W 916 x D 126
Heat Output	0.75kW - 1.5kW

Finish

	Black Glass
Model Number	CFECEORE-ERP

ACCENT TRADITIONAL

Hearth Inset Fire



Video



Features

- Open fire experience
- Lively ribbon flame effect
- Coal effect fuel bed
- LED brightness control
- Thermostatic remote & manual control operation



Chrome

Finish

- Steel Fabricated
Metallic Plated Trim
- Brass CREC1SRE2
 - Chrome CREC37RE2

Model Number

ACCENT INFUSION

Hearth Inset Fire



Video



Features

- Open fire experience
- Lively ribbon flame effect
- Coal effect fuel bed
- LED brightness control
- Thermostatic remote & manual control operation



Brass & Black



Black & Chrome

Finish

- Steel Fabricated Fascia
Dual Metallic & Painted
- Brass & Black CREC10RE2
 - Black & Chrome CREC20RE2
 - Chrome & Satin Silver CREC30RE2

Model Number

Specification

Dimensions: mm	H 595 x W 498 x D 83
Heat Output	1.0kW - 2.0kW

Specification

Dimensions: mm	H 595 x W 490 x D 35
Heat Output	1.0kW - 2.0kW

Freestanding Suites 8-19

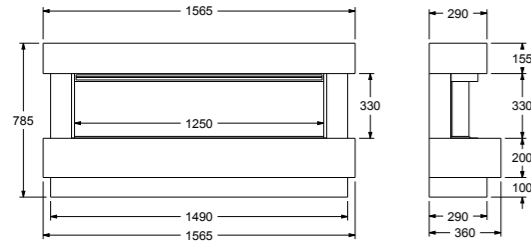

QUANTUM S1250

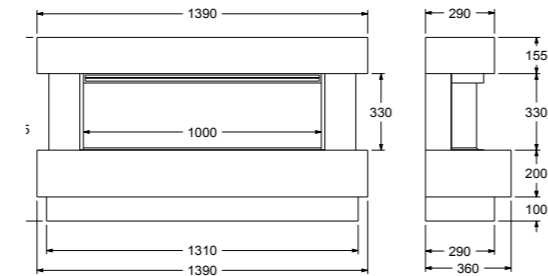

QUANTUM S1000

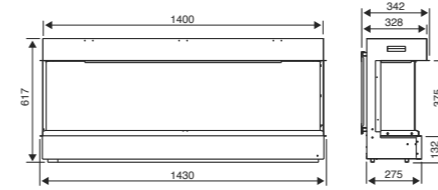

1400

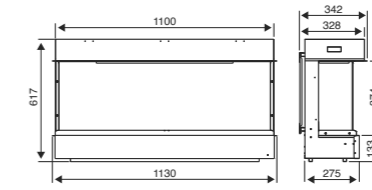

1100

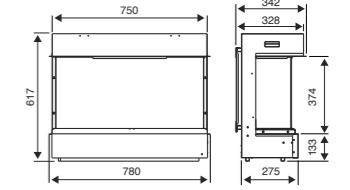

750

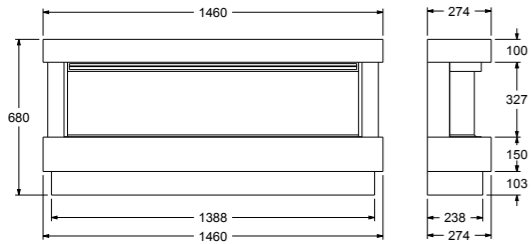

E-VR CASINO S1250

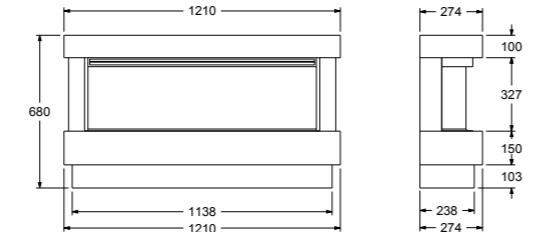

E-VR CASINO S1000

Wall Mounted 3 Sided Suites 31-33

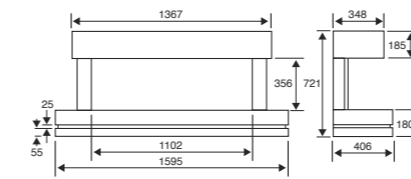

VOLARE 1100 ILLUMIA

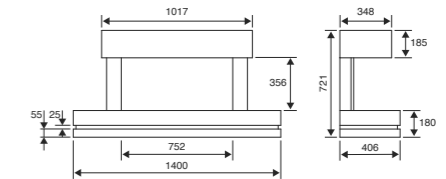

VOLARE 750 ILLUMIA

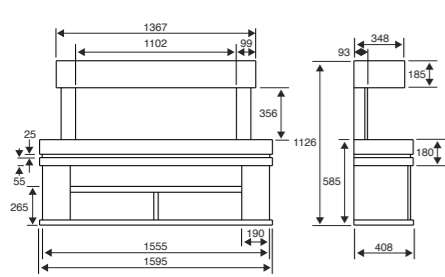

MEDIA 1100 ILLUMIA

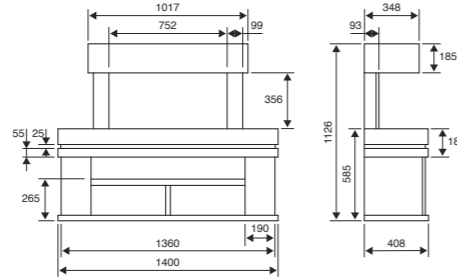

MEDIA 750 ILLUMIA

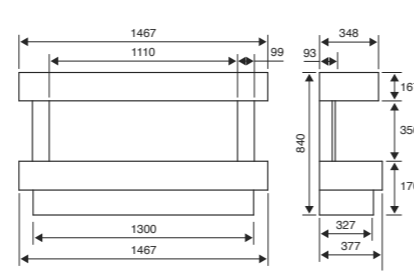

CARINO 1100 ILLUMIA

Wall Inset Fires 30-35

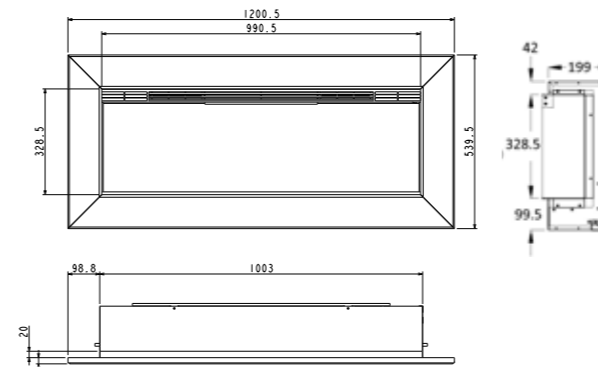

COMMODUS S1000 + FASCIA

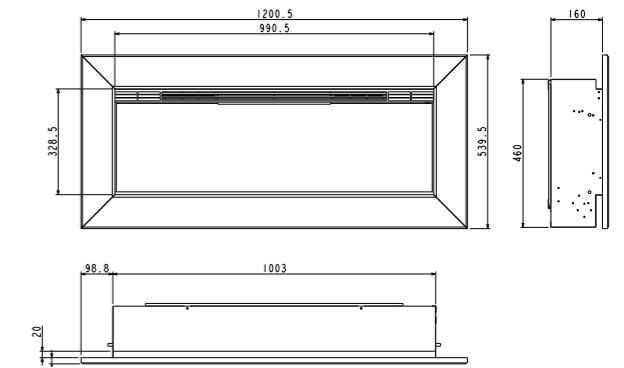

COMMODUS + FASCIA

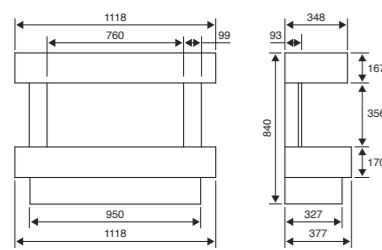

CARINO 750 ILLUMIA

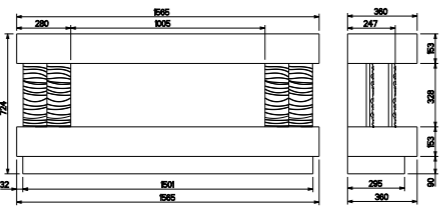

TORONTO 1000 ILLUMIA

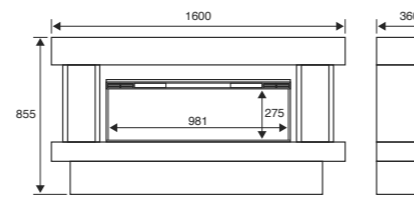

ORBITAL 1000 ILLUMIA

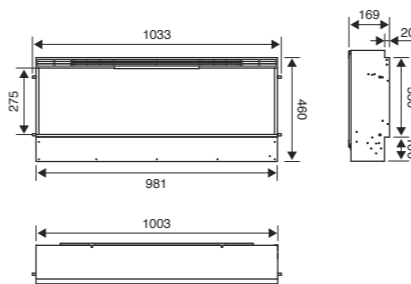

COMMODUS

Built-In 3 Sided Glass Fires 20-30

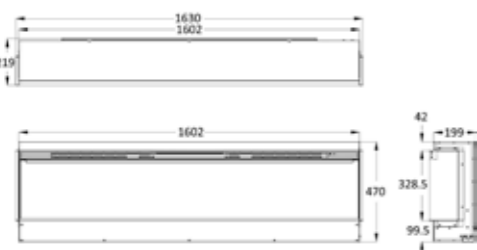

COMMODUS S1600



COMMODUS S1250

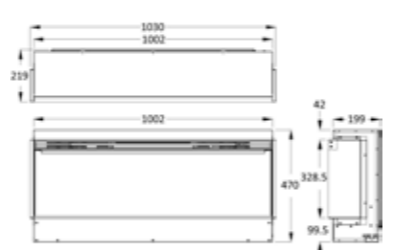

COMMODUS S1000

Wall Mounted Fires 36-37

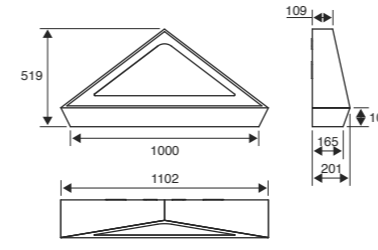

LOUVRE

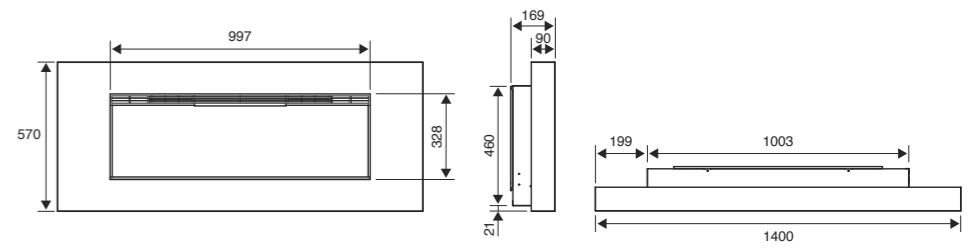

BASILICA

Hearth Inset Fires 38-41

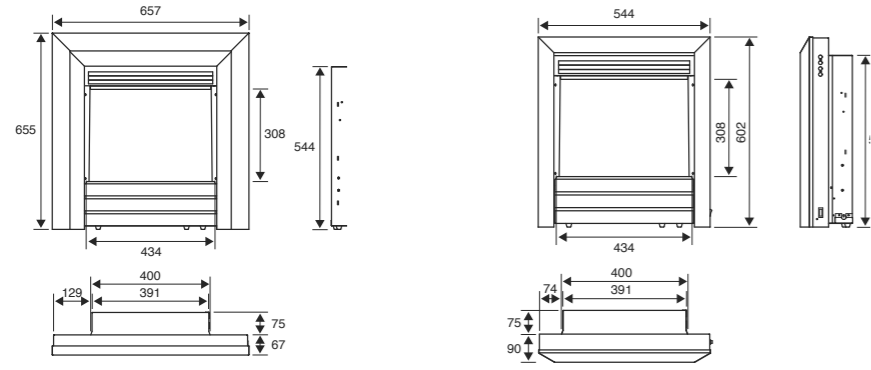

ACERO

PARRILLA

ELECTRISTOVE® H3D/VR

Stoves 42-51

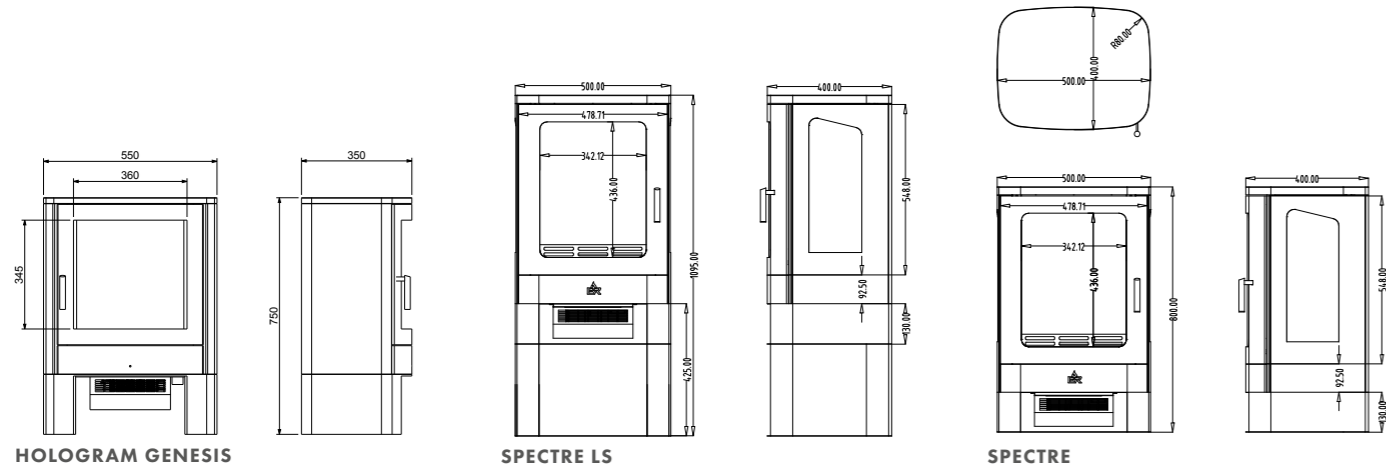

HOLOGRAM GENESIS

SPECTRE LS

SPECTRE

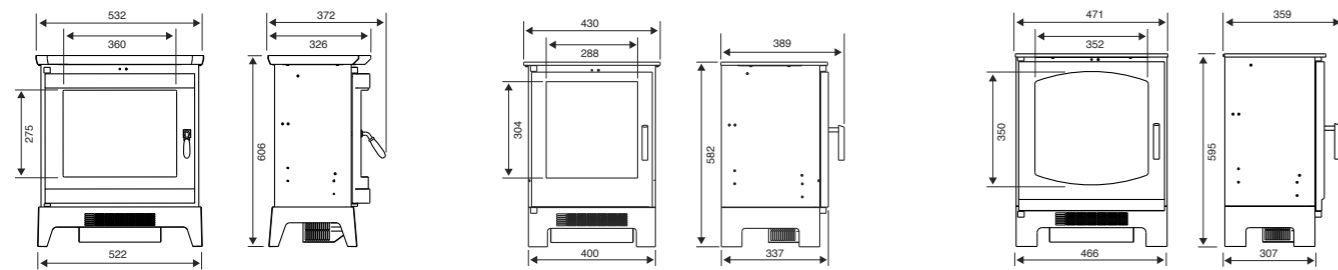

ROCHESTER

ARUNDEL

LUXIMA

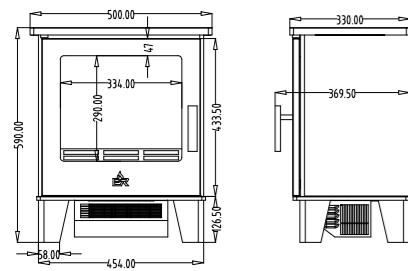

STRATFORD

Firebeam Suites 54-61

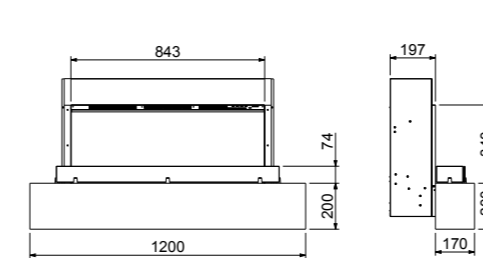

FIREBEAM 800 ILLUMIA

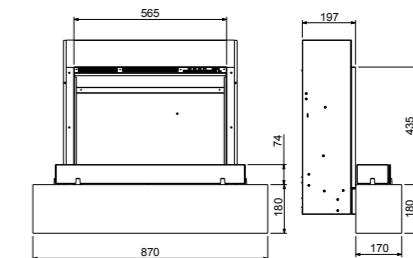

FIREBEAM S600 ILLUMIA

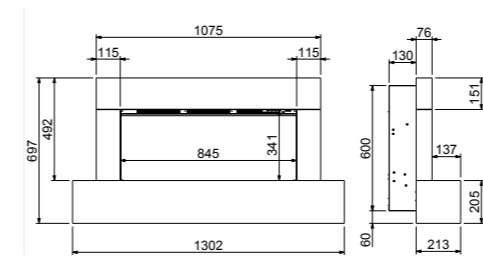

FIREBEAM XL 800 ILLUMIA

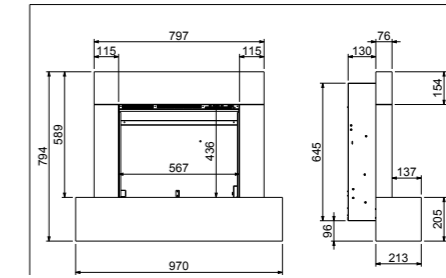

FIREBEAM XL S600 ILLUMIA

Freestanding Suites 62-79

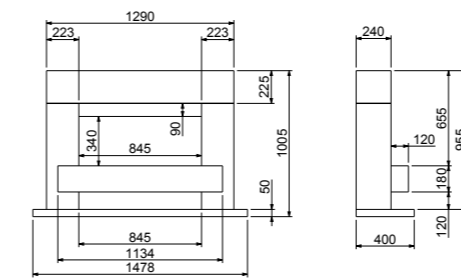

LUMINAIRE 800 ILLUMIA

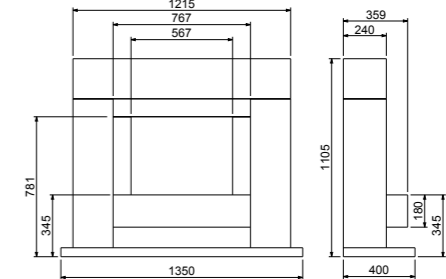

LUMINAIRE 600 ILLUMIA

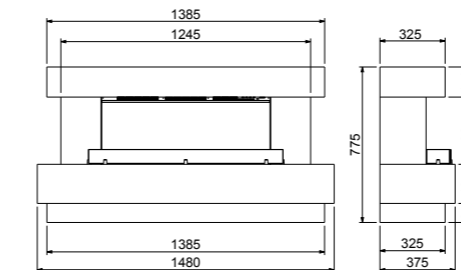

SKYFALL 800 ILLUMIA

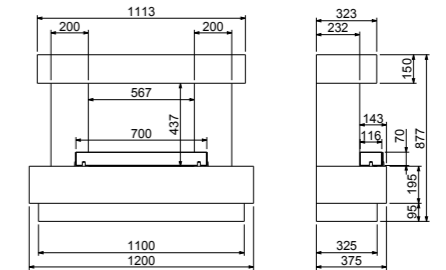

SKYFALL S600 ILLUMIA

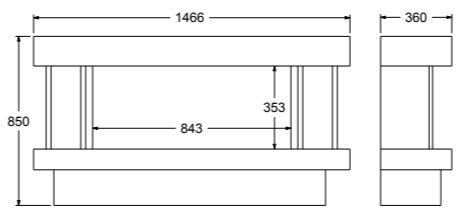

ORBITAL 800 ILLUMIA

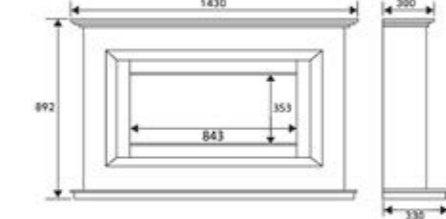

VEGA

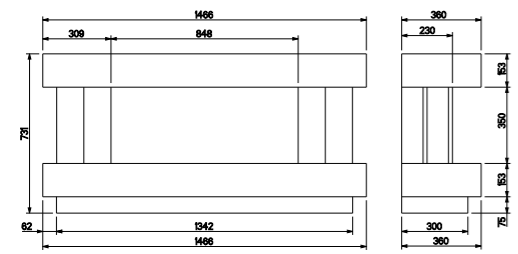

TORONTO 800 ILLUMIA

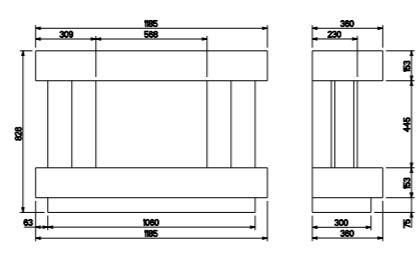

TORONTO S600 ILLUMIA

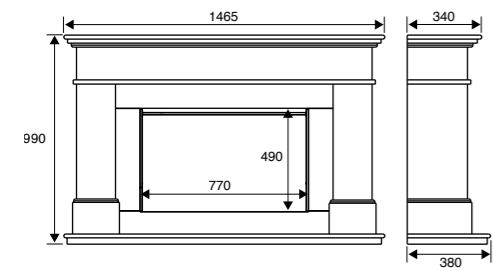

ADOUR ALEESIA ILLUMIA

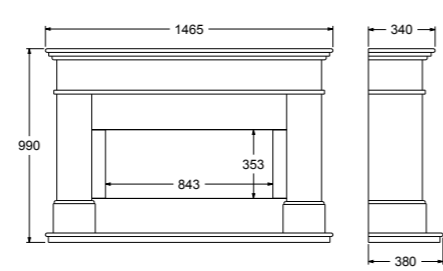

ADOUR ELITE ILLUMIA

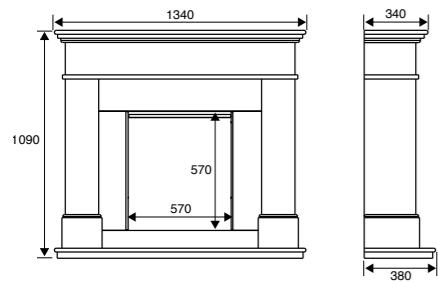

ADOUR ASENCIO S ILLUMIA

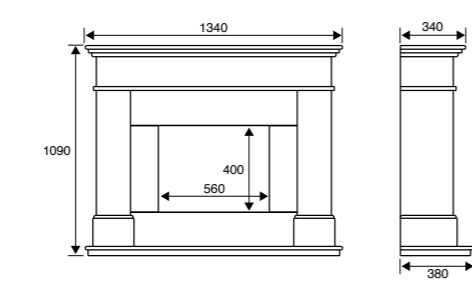

ADOUR S600 ILLUMIA

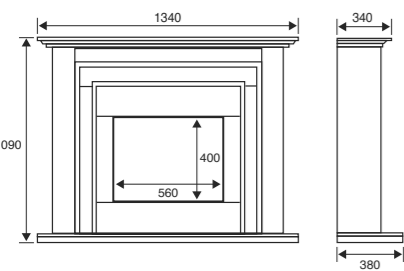

CANELO S600 ILLUMIA

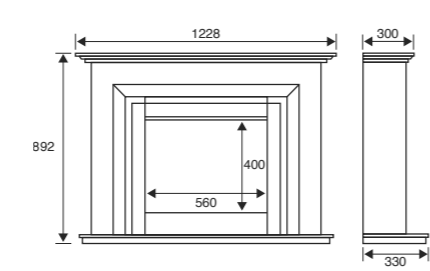

ELARA S600

Inset Limestone Suites 80-86



PARADA ELITE ILLUMIA

AVIGNON ELITE

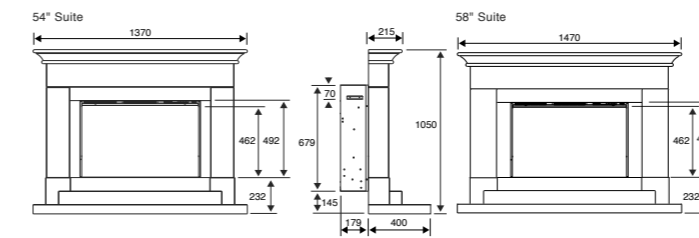

ALEESIA ILLUMIA

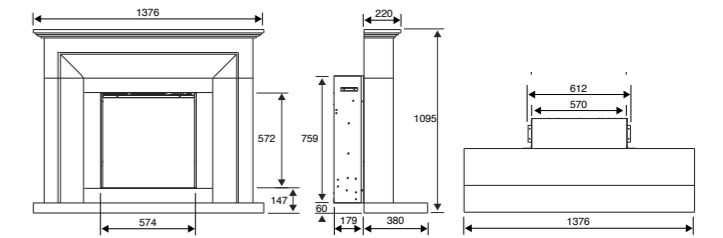

ASENCIO S

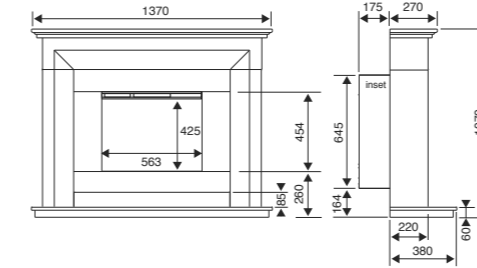

ANGELO S600

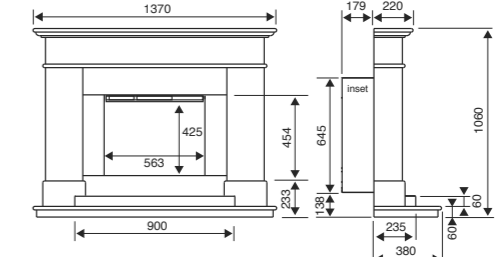

BOTICELLI S600

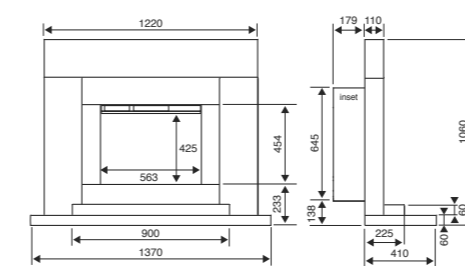

PABLO S600

Wall Inset Fires 87-95

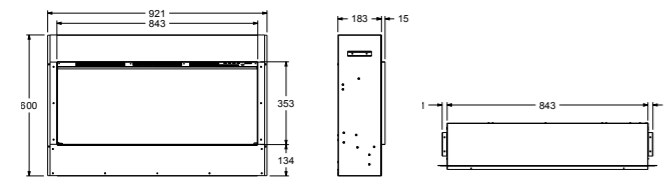

ELITE

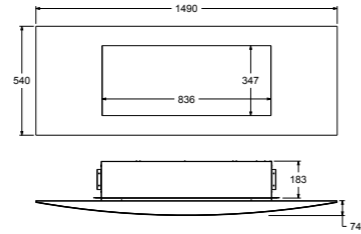

VICHY

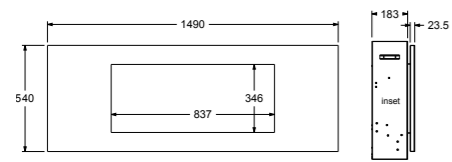

METZ

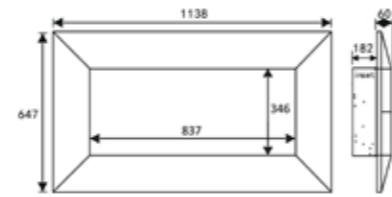

INSTINCT

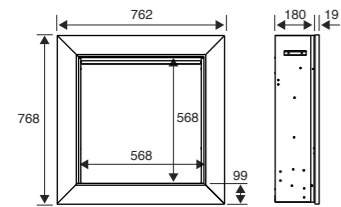

EVORA ASENCIO S

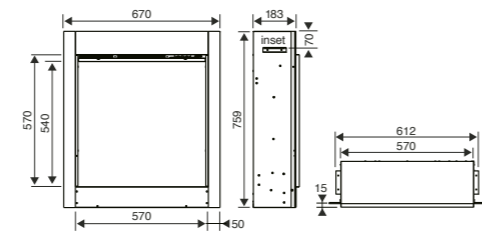

ASENCIO S

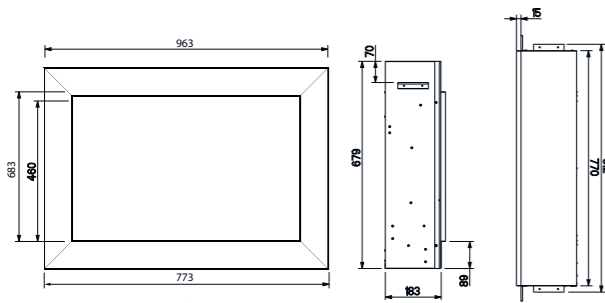

VADER ALEESIA

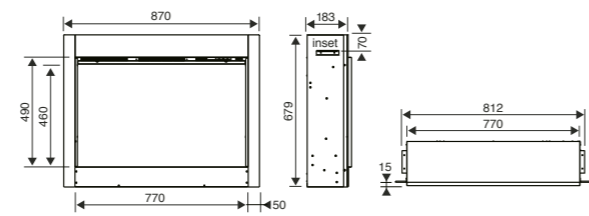

ALEESIA

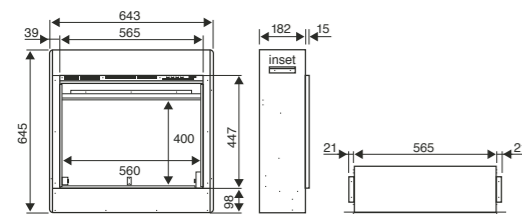

CELENA S600

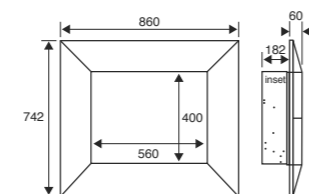

IMPULSE S600

Hearth Inset Fires 96-103

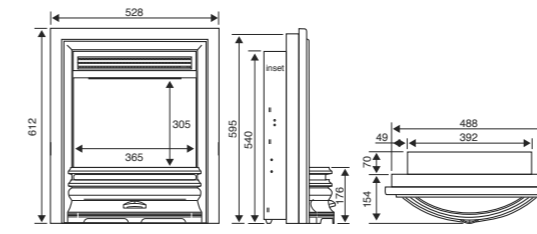

ARCADIA

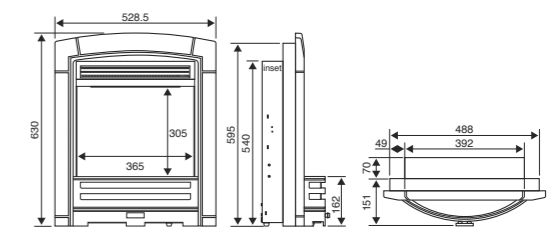

DECADENCE

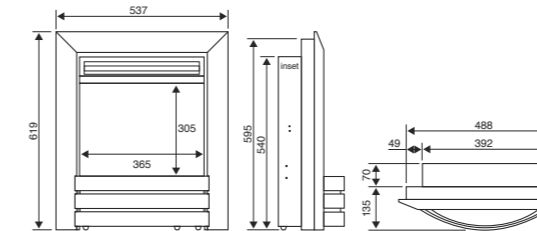

CAMBER

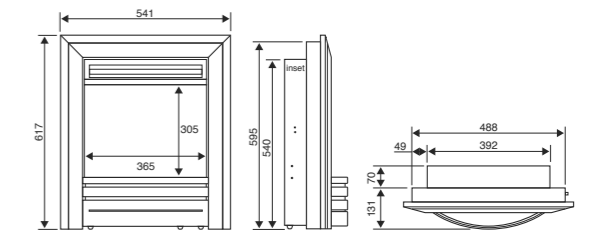

FRONTIER

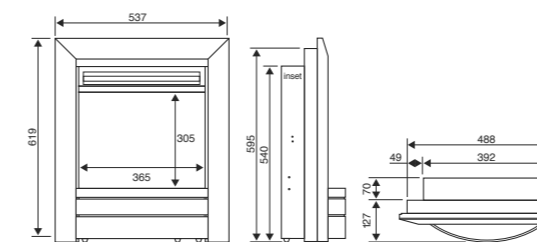

ESSENCE

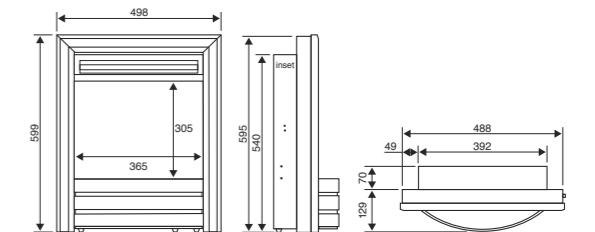

DESIGNER

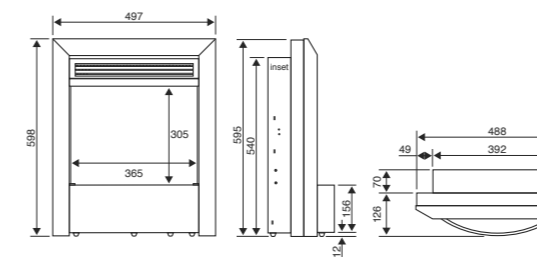

ENDURA

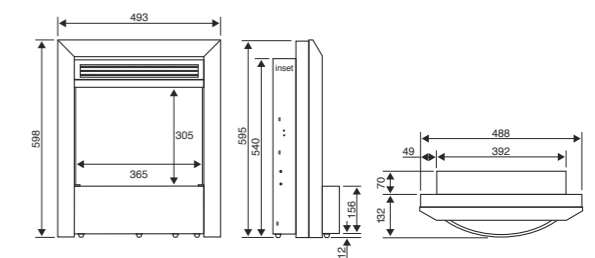

CONTEMPORARY

ELECTRIFLAME® XD

Wall Mounted Fires 104-109

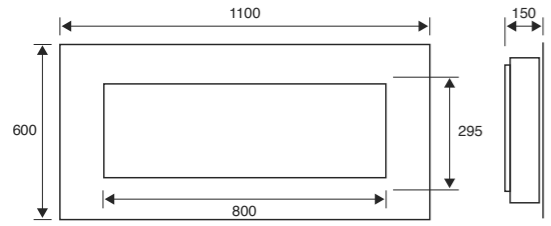

PRESTIGE

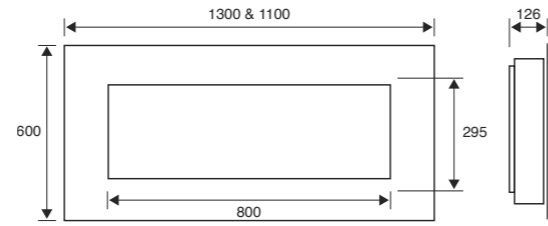

BLACK GLASS

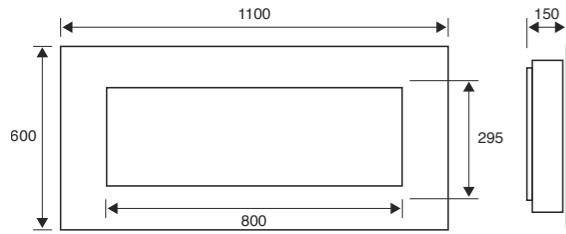

ROYAL BOTTICINO

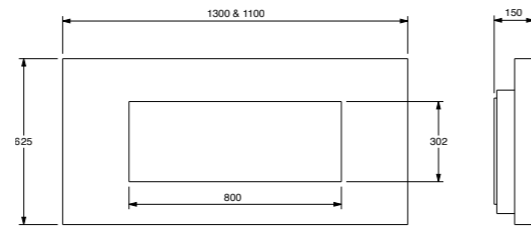

TRAVERTINE

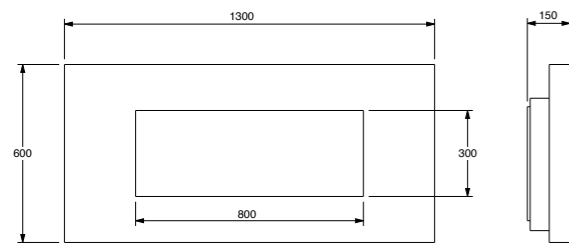

PIANO BLACK

FLAMONIK

Dimensions: mm

Wall Outset 122-123

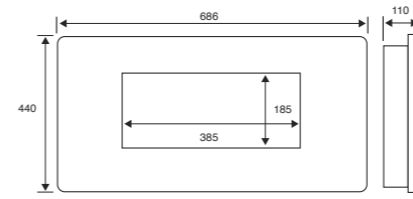

RAPTURE

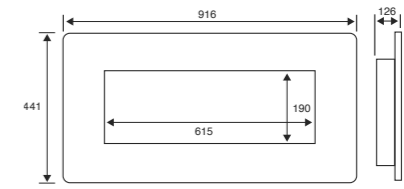

ENCHANT

ACCENT

Hearth Inset 124-125

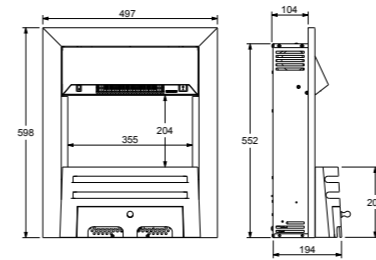

ACCENT TRADITIONAL

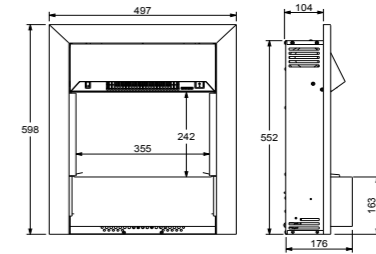

ACCENT INFUSION

ELECTRISTOVE® XD

Stoves 118-121

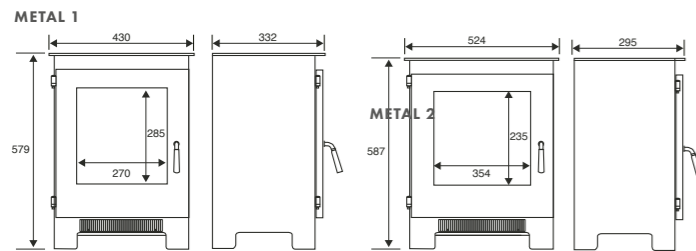

ELECTRISTOVE METAL

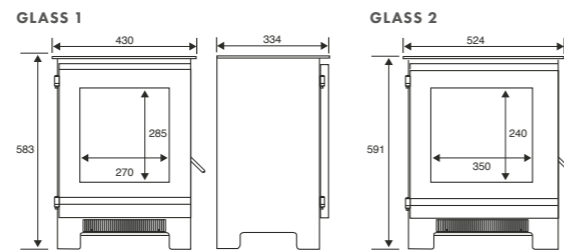

ELECTRISTOVE GLASS



DISCLAIMER

Our policy is one of constant development and improvement. We therefore reserve the right to revise designs and specifications of our products without formal notice, patents pending. We always recommend our products be viewed in an approved showroom before purchase. Whilst we have taken every care in the preparation of this brochure it is not intended to replace the installation manual which provides more detailed information.

Photography is for illustration purposes only and although every effort has been made to ensure accurate reproduction of typical installations and flame pictures they may vary according to fire model and flue types.

We accept no liability for any loss or damage arising directly or indirectly from the use of this brochure.

We recommend that all our fires are used in conjunction with central heating and not as a primary source of heat.

In the interests of personal safety a suitable fireguard is recommended when children, the elderly and the infirm are present.

This brochure is copyright and must not be reproduced in whole or in any part without prior written permission.



BFM Europe Ltd, Gordon Banks Drive,
Trentham Lakes, Stoke-on-Trent ST4 4TJ

Tel: 01782 339000

Email: sales@bfm-europe.com

www.celsielectricfires.co.uk

Go direct to the Celsi website on your smart phone or tablet device and use the app to scan the black and white QR codes shown on each page. Alternatively, go to www.celsielectricfires.co.uk to browse all Celsi electric fires.

